

Technical Overview

G3 Digital Cutter

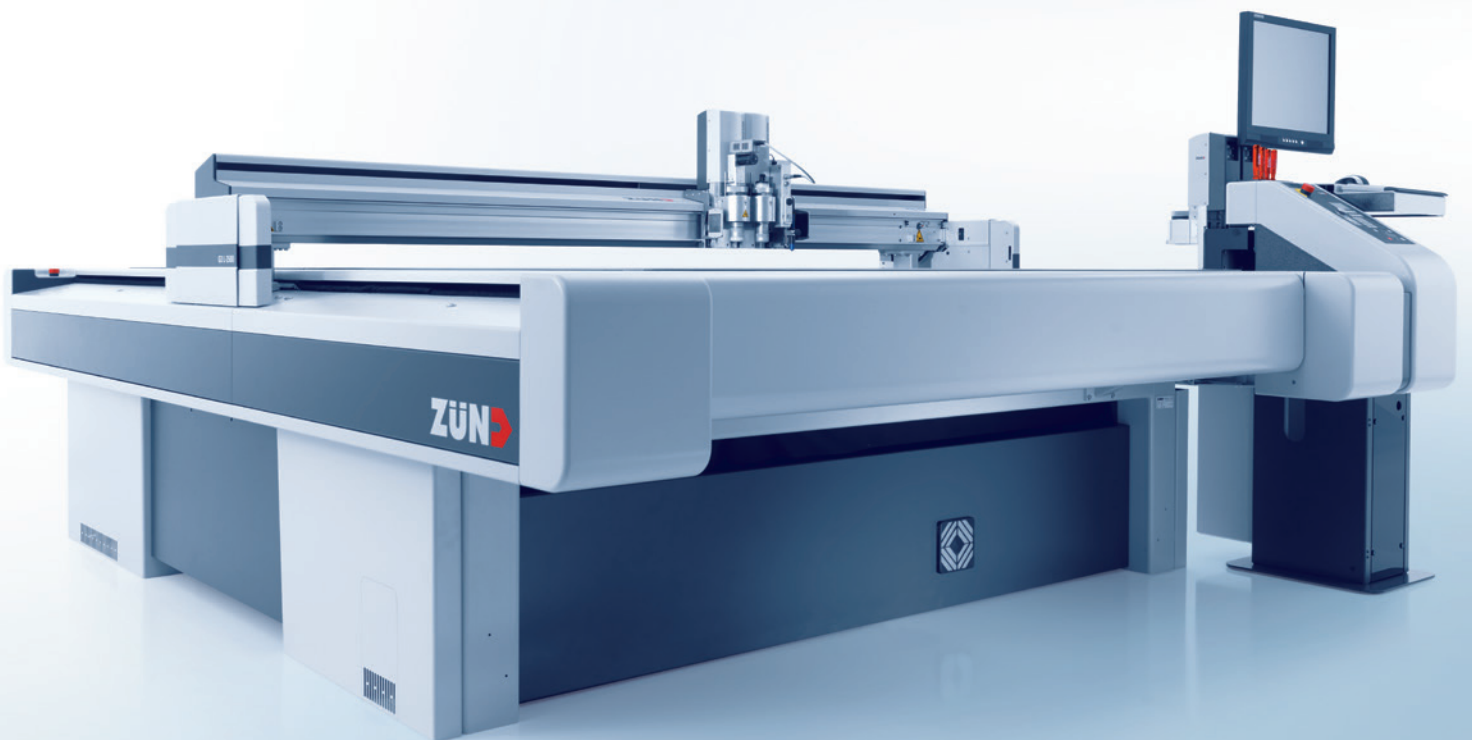

Your first choice in digital cutting.

G3 digital cutting systems

Perfection is in the details

Modular tooling

Select the Zünd tools that will make up the perfect G3 cutter configuration for you.

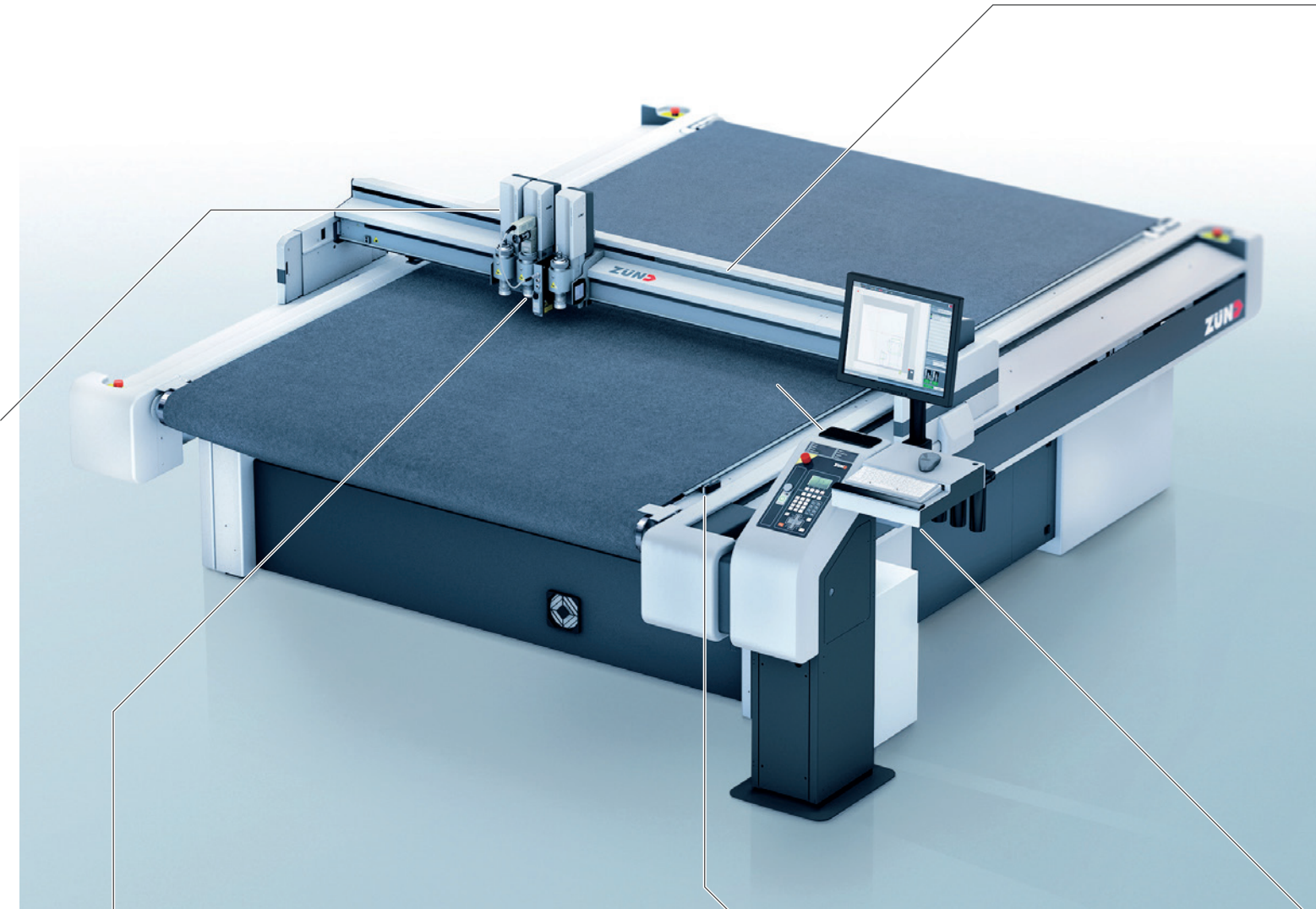
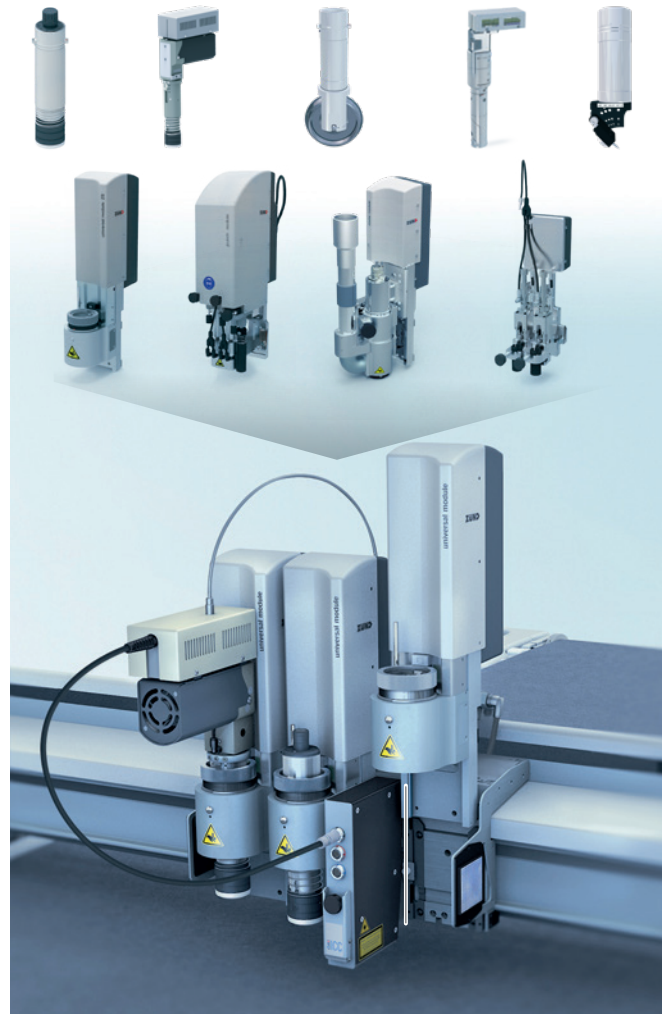

Process materials up to 110 mm

G3 cutters are available with a beam height of 30, 60 or 120 mm. Depending on the configuration, up to 110 mm thick materials may be processed. For you this translates into added flexibility and versatility in meeting your customers' demands.



Efficient tool management

Zünd's distinctive modular design allows you to configure the required tooling in a few quick, easy steps. The resulting flexibility lets you react instantaneously to changes in production requirements, saving you both time and money.

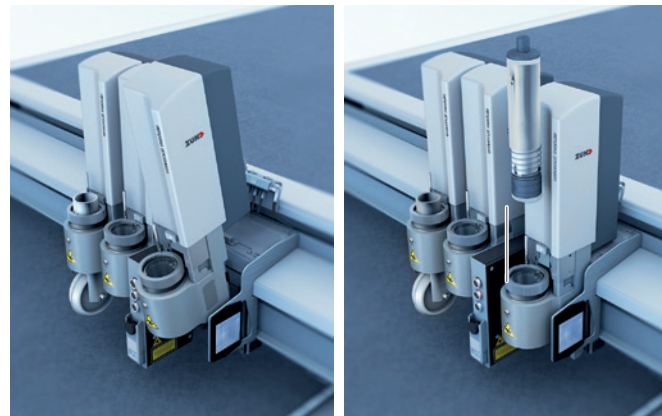

Precision in every detail

Zünd cutters are high-precision machines. All components – from drive system to cutting blade – are designed and manufactured to work together perfectly. This lets you produce efficiently and wow your customers with perfect results.

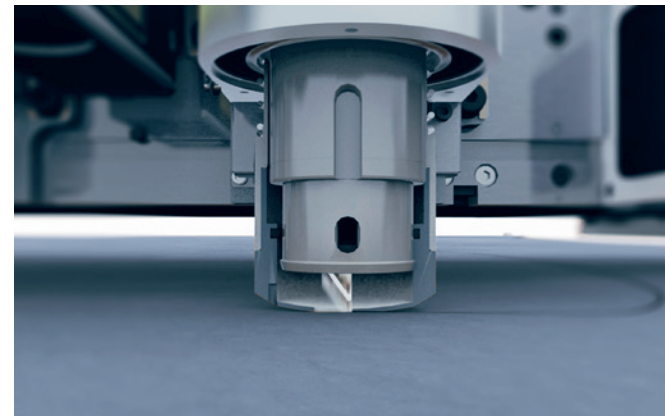

Integrated tool initialization

Quick, precise, time-saving: the setting of knives, routers, and creasing wheels takes place via the fully automatic initialization system. Manual adjustment work to determine the cutting depth is no longer necessary.

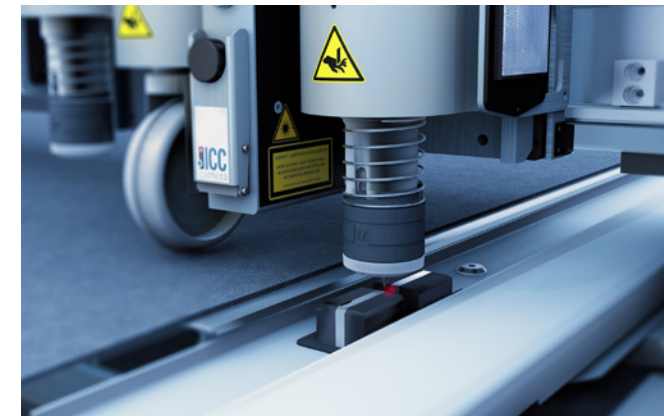

Optimal material hold-down

The material hold-down is based on vacuum. The vacuum area is divided into separate zones and adjustable across the width of the machine. Energy-efficient vacuum generators guarantee reliable hold-down during processing.

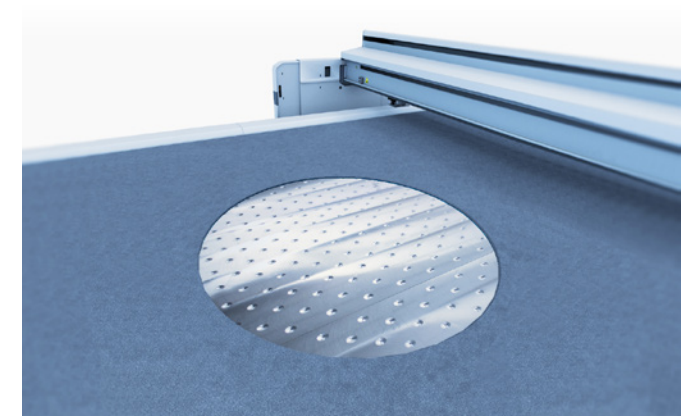

G3 digital cutting systems

Intelligent, efficient, ready for the future

Ergonomics and operation

The G3 construction and design are tailored to the needs of our customers. Simple, user-friendly and ergonomic operation are the result.



Software and machine from a single source

Zünd Cut Center includes an extensive material database with optimal cutting parameters for every material and every Zünd tool. The software is completely integrated in the digital workflow and efficiently supports the user in every phase of job preparation.

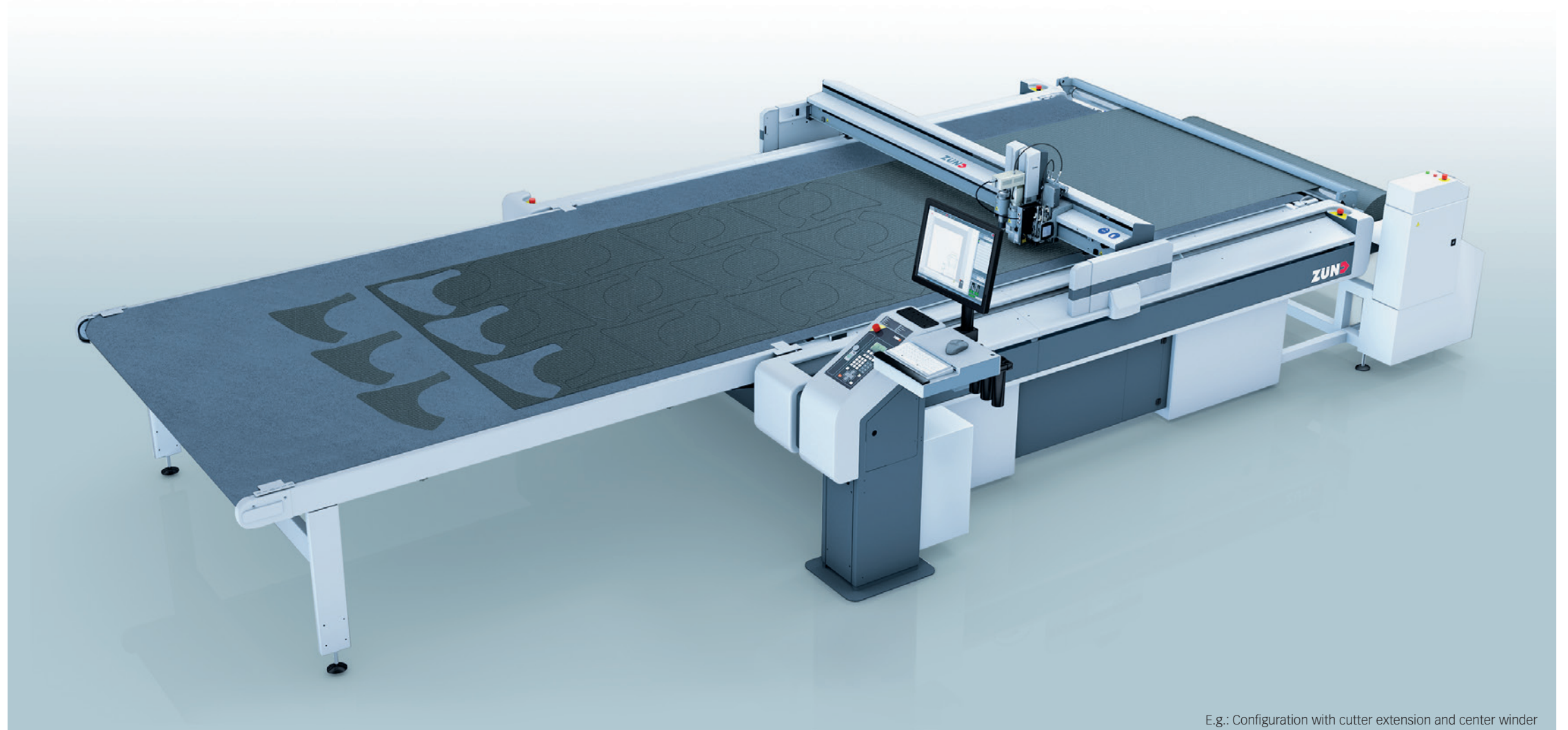

E.g.: Configuration with cutter extension and center winder

11 different cutter sizes

No matter the product or whether you produce small runs, large runs or prototypes, the G3 line of cutters lets you select the perfect machine size for all your production needs.

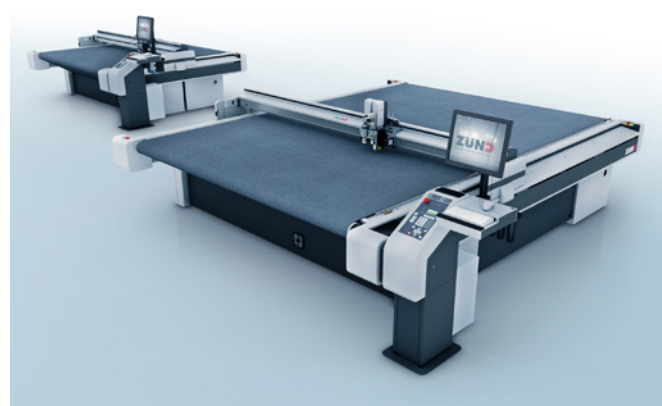

Powerful and robust

Zünd high-performance cutters are designed for 24/7 operation. Because we use only robust, high-quality components, you can depend on your G3 for consistently high output quality, reliability and extraordinary longevity.

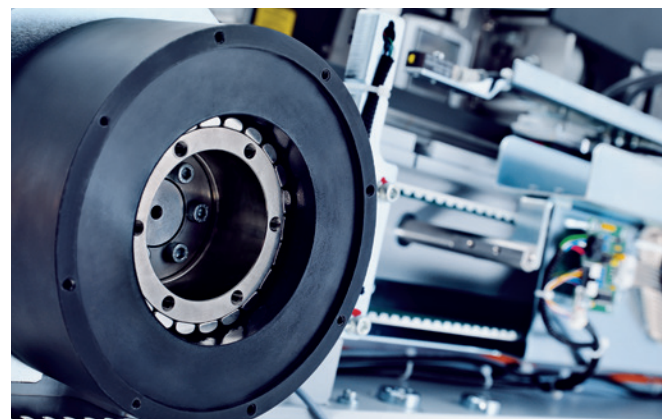

Cutting carbon fiber

Zünd cutters used in carbon fiber applications are effectively sealed off against particles entering the controls. Powerful cutting tools process composite materials precisely and without displacing any fibers.

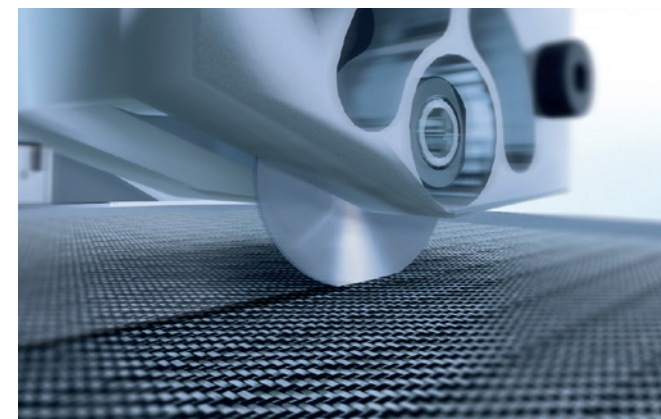

Intelligent safety features

High safety standards are a primary concern for many of our customers in commerce and industry. The G3 safety features actively support the operator and interfere only when absolutely necessary.



G3 configuration choices Investing in the future

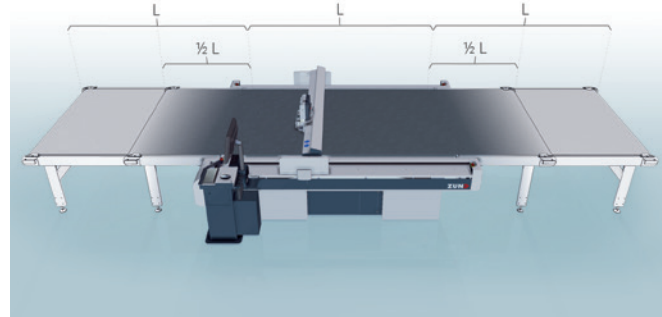

Systems for success

The base machine provides the foundation of the Zünd modular tool concept. All options and tools are designed to be building blocks you can choose to add on to your configuration at any time, easily and cost-effectively.

No matter how you configure your Zünd cutting system today, it will be a safe investment for tomorrow.

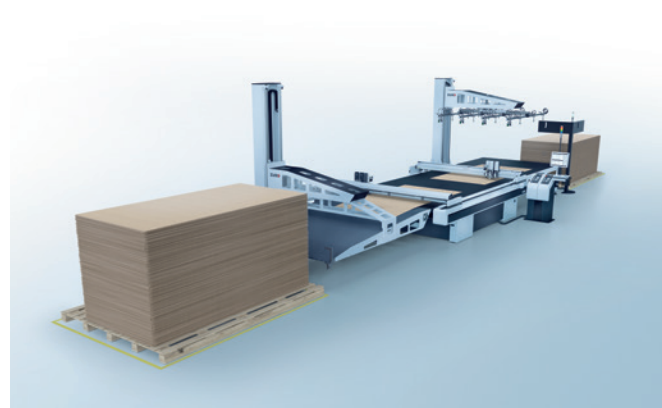

Fully automated production - BHS

High volume, high quality and flexibility - with the Zünd Board Handling System, you can run 24/7 non-stop production with minimal personnel! Fully automated board loading and unloading limits the necessary labor to bringing in/removing pallets of stacked uncut/cut media.

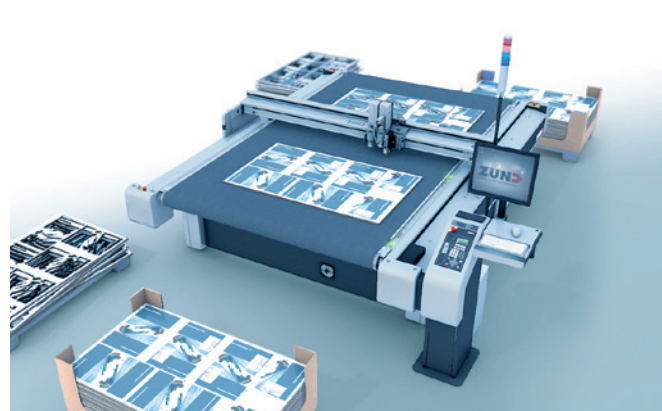

Semi-automated production

In a tandem operation workflow, loading/unloading occurs concurrently with production. The operator loads/unloads material on one side of the machine, while the cutter continues operating on the other. This setup increases productivity by keeping idle time to a minimum and maximizing throughput.

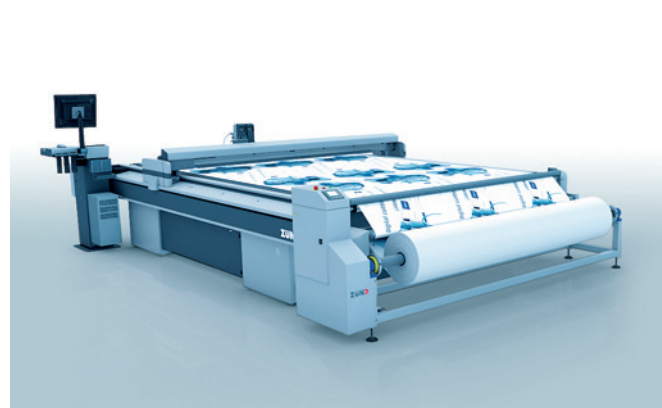

Fully automated roll handling

The heavy-duty design of the Zünd Center Winder permits processing rolls that weigh up to 100 kg. A sophisticated dancer system ensures constant material tension. Even the most challenging textiles are fed onto the machine without wrinkles or undue stretch.

In addition to unwinding, the motor-driven Center Winder can be used for rewinding material back onto the roll.

Solid reasons for Zünd G3



Zünd

Zünd Systemtechnik AG - family-owned and based in Switzerland - specializes in digital cutting systems. The Zünd name represents Swiss quality and has become synonymous with precision, performance and reliability.

Since 1984 we have been designing, producing and marketing modular cutting systems and have gained a global reputation as market leader. The technological superiority of our products stems from our insistence on high quality standards, modular design and focus on our customers.

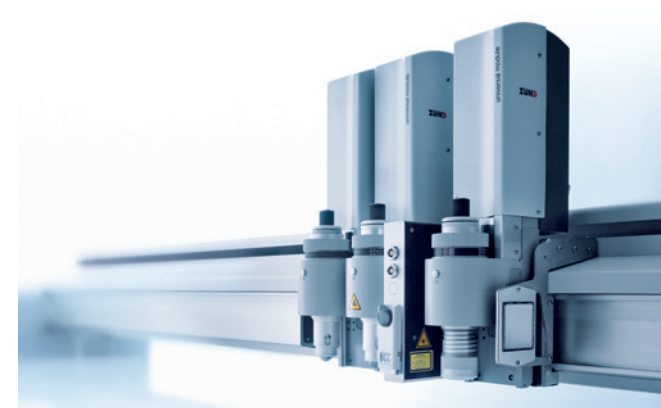

Modularity

Zünd cutting systems are based on a design concept that lends them greater flexibility and adaptability than any others on the market can offer. This unique modularity makes it possible to cost-effectively configure and upgrade Zünd cutters for ever-changing cutting needs. This contributes to their exceptional ROI and makes them retain their value over many years.



Profitability

Solid performance, outstanding quality - thousands of Zünd cutting systems worldwide are producing non-stop and offer daily proof of their unparalleled profitability.

Innovative technology and superior standards of construction guarantee low maintenance costs. Outstanding energy efficiency is yet another benefit of our products. Optimal processing methods, state-of-the-art vacuum generators and sophisticated material-advance systems keep energy demands low and contribute to the eco-friendliness and sustainability of our products.



Worldwide service

What applies to our cutting systems, also applies to our service: Exceptional performance, precision and reliability. Optimally trained and highly experienced specialists are always at your disposal.

Zünd technicians all over the world are only a phone call away. Our subsidiaries and distribution partners in your vicinity strive to keep response times to a minimum and are ready to provide support whenever the need arises.

G3 digital cutting systems

Choice of sizes

09/2018



S3 M-800
1330 x 830 mm



S3 M-1200
1330 x 1230 mm



S3 L-1200
1800 x 1230 mm

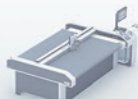

S3 XL-1200
2270 x 1230 mm

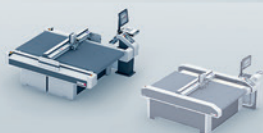

G3/S3 M-1600
1330 x 1600/1630 mm

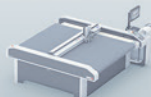

S3 L-1600
1800 x 1630 mm

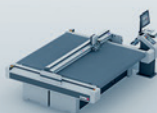

G3 XL-1600
2270 x 1600 mm

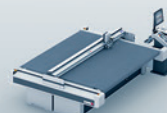

G3 2XL-1600
2740 x 1600 mm

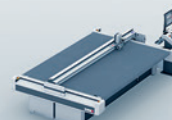

G3 3XL-1600
3210 x 1600 mm

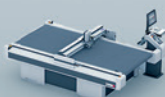

G3 M-2500
1330 x 2500 mm

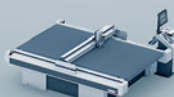

G3 L-2500
1800 x 2500 mm

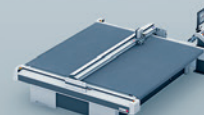

G3 3XL-2500
3210 x 2500 mm

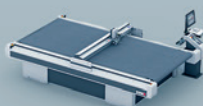

G3 L-3200
1800 x 3200 mm

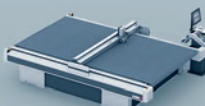

G3 XL-3200
2270 x 3200 mm

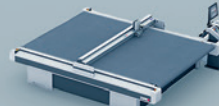

G3 2XL-3200
2740 x 3200 mm

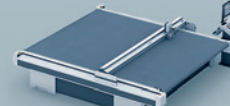

G3 3XL-3200
3210 x 3200 mm

Canon Production Printing Australia

Unipark, Building 1
195 Wellington Road
Clayton Vic 3168
T 1300 363 440
support.au@cpp.canon
anz.cpp.canon/zund

Zünd Systemtechnik AG

Industriestrasse 8
CH-9450 Altstätten
T +41 71 554 81 00
info@zund.com
www.zund.com

Canon

CANON PRODUCTION PRINTING AUSTRALIA

ZUND
swiss cutting systems